

500 mA Positive Voltage Regulators

MC78M00, MC78M00A, NCV78M00 Series

Description

The MC78M00/MC78M00A Series positive voltage regulators are identical to the popular MC7800 Series devices, except that they are specified for only half the output current. Like the MC7800 devices, the MC78M00 three-terminal regulators are intended for local, on-card voltage regulation.

Internal current limiting, thermal shutdown circuitry and safe-area compensation for the internal pass transistor combine to make these devices remarkably rugged under most operating conditions. Maximum output current, with adequate heatsinking is 500 mA.

Features

- No External Components Required
- Internal Thermal Overload Protection
- Internal Short Circuit Current Limiting
- Output Transistor Safe-Area Compensation
- MC78M00A High Accuracy ($\pm 2\%$)
Available for 5.0 V, 8.0 V, 12 V and 15 V
- NCV Prefix for Automotive and Other Applications Requiring Unique Site and Control Change Requirements; AEC-Q100 Qualified and PPAP Capable
- These are Pb-Free Devices



DPAK-3
DT SUFFIX
CASE 369C

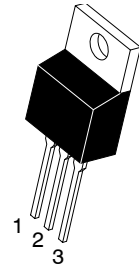

TO-220
T SUFFIX
CASE 221AB

MARKING DIAGRAMS



Heatsink surface
connected to Pin 2.

- xx = Voltage Option
- XX = Appropriate Suffix Options
- A = Assembly Location
- WL = Wafer Lot
- Y = Year
- WW = Work Week
- G = Pb-Free Package

Heatsink surface (shown as terminal 4 in case outline drawing) is connected to Pin 2.

- xxxxx = Device Type and Voltage Option Code
- A = Assembly Location
- L = Wafer Lot
- Y = Year
- WW = Work Week
- G = Pb-Free Package

- Pin 1. Input
- 2. Ground
- 3. Output



This device contains 28 active transistors.

Figure 1. Representative Schematic Diagram

ORDERING INFORMATION

See detailed ordering and shipping information in the package dimensions section on page 10-14 of this data sheet.

DEVICE MARKING INFORMATION

See general marking information in the device marking section on page 10 of this data sheet.

MC78M00, MC78M00A, NCV78M00 Series

MAXIMUM RATINGS ($T_A = 25^\circ\text{C}$, unless otherwise noted) (Note 1)

| Rating | Symbol | Value | Unit |
|---|--|--|---------------------------|
| Input Voltage (5.0 V–18 V) (20 V–24V) | V_I | 35 40 | Vdc |
| Power Dissipation (Package Limitation) Plastic Package, T Suffix $T_A = 25^\circ\text{C}$ Thermal Resistance, Junction-to-Air Thermal Resistance, Junction-to-Case Plastic Package, DT Suffix $T_A = 25^\circ\text{C}$ Thermal Resistance, Junction-to-Air Thermal Resistance, Junction-to-Case | P_D θ_{JA} θ_{JC} P_D θ_{JA} θ_{JC} | Internally Limited 70 5.0 Internally Limited 92 5.0 | $^\circ\text{C}/\text{W}$ |
| Operating Junction Temperature Range | T_J | +150 | $^\circ\text{C}$ |
| Storage Temperature Range | T_{stg} | -65 to +150 | $^\circ\text{C}$ |

Stresses exceeding those listed in the Maximum Ratings table may damage the device. If any of these limits are exceeded, device functionality should not be assumed, damage may occur and reliability may be affected.

- This device series contains ESD protection and exceeds the following tests:
Human Body Model 2000 V per MIL-STD-883, Method 3015.
Machine Model Method 200 V.

MC78M05C/AC/B/AB, NCV78M05AB/B ELECTRICAL CHARACTERISTICS

($V_I = 10\text{ V}$, $I_O = 350\text{ mA}$, $T_J = T_{low}$ to T_{high} , $P_D \leq 5\text{ W}$, unless otherwise noted) (Note 2)

| Characteristics | Symbol | Min | Typ | Max | Unit |
|--|-------------------------|--------------|------------|--------------|----------------------------|
| Output Voltage ($T_J = 25^\circ\text{C}$) MC78M05B/MC78M05C/NCV78M05B MC78M05AB/MC78M05AC/NCV78M05AB | V_O | 4.8 4.9 | 5.0 5.0 | 5.2 5.1 | Vdc |
| Output Voltage Variation ($7.0\text{ Vdc} \leq V_I \leq 20\text{ Vdc}$, $5.0\text{ mA} \leq I_O \leq 350\text{ mA}$) MC78M05B/MC78M05C/NCV78M05B MC78M05AB/MC78M05AC/NCV78M05AB | V_O | 4.75 4.80 | – – | 5.25 5.20 | Vdc |
| Line Regulation ($T_J = 25^\circ\text{C}$, $7.0\text{ Vdc} \leq V_I \leq 25\text{ Vdc}$, $I_O = 200\text{ mA}$) | Reg_{line} | – | 3.0 | 50 | mV |
| Load Regulation ($T_J = 25^\circ\text{C}$, $5.0\text{ mA} \leq I_O \leq 500\text{ mA}$) ($T_J = 25^\circ\text{C}$, $5.0\text{ mA} \leq I_O \leq 200\text{ mA}$) | Reg_{load} | – – | 20 10 | 100 50 | mV |
| Input Bias Current ($T_J = 25^\circ\text{C}$) | I_{IB} | – | 3.2 | 6.0 | mA |
| Quiescent Current Change ($8.0\text{ Vdc} \leq V_I \leq 25\text{ Vdc}$, $I_O = 200\text{ mA}$) ($5.0\text{ mA} \leq I_O \leq 350\text{ mA}$) | ΔI_{IB} | – – | – – | 0.8 0.5 | mA |
| Output Noise Voltage ($T_A = 25^\circ\text{C}$, $10\text{ Hz} \leq f \leq 100\text{ kHz}$) | V_n | – | 40 | – | μV |
| Ripple Rejection ($I_O = 100\text{ mA}$, $f = 120\text{ Hz}$, $8.0\text{ V} \leq V_I \leq 18\text{ V}$) ($I_O = 300\text{ mA}$, $f = 120\text{ Hz}$, $8.0 \leq V_I \leq 18\text{ V}$, $T_J = 25^\circ\text{C}$) | RR | 62 62 | – 80 | – – | dB |
| Dropout Voltage ($T_J = 25^\circ\text{C}$) | $V_I - V_O$ | – | 2.0 | – | Vdc |
| Short Circuit Current Limit ($T_J = 25^\circ\text{C}$, $V_I = 35\text{ V}$) | I_{OS} | – | 350 | – | mA |
| Average Temperature Coefficient of Output Voltage ($I_O = 5.0\text{ mA}$) | $\Delta V_O / \Delta T$ | – | ± 0.2 | – | $\text{mV}/^\circ\text{C}$ |
| Peak Output Current ($T_J = 25^\circ\text{C}$) | I_O | – | 700 | – | mA |

- $T_{low} = 0^\circ\text{C}$ for MC78MxxAC, C
= -40°C for MC78MxxAB, B, NCV78MxxAB, B
 $T_{high} = +125^\circ\text{C}$ for MC78MxxAB, AC, B, C, NCV78MxxAB, B

MC78M00, MC78M00A, NCV78M00 Series

MC78M06C/B ELECTRICAL CHARACTERISTICS

($V_I = 11\text{ V}$, $I_O = 350\text{ mA}$, $T_J = T_{\text{low}}$ to T_{high} , $P_D \leq 5.0\text{ W}$, unless otherwise noted) (Note 3)

| Characteristics | Symbol | Min | Typ | Max | Unit |
|---|----------------------------|----------|-----------|------------|----------------------------|
| Output Voltage ($T_J = 25^\circ\text{C}$) | V_O | 5.75 | 6.0 | 6.25 | Vdc |
| Output Voltage Variation ($8.0\text{ Vdc} \leq V_I \leq 21\text{ Vdc}$, $5.0\text{ mA} \leq I_O \leq 350\text{ mA}$) | V_O | 5.7 | – | 6.3 | Vdc |
| Line Regulation ($T_J = 25^\circ\text{C}$, $8.0\text{ Vdc} \leq V_I \leq 25\text{ Vdc}$, $I_O = 200\text{ mA}$) | Reg_{line} | – | 5.0 | 50 | mV |
| Load Regulation ($T_J = 25^\circ\text{C}$, $5.0\text{ mA} \leq I_O \leq 500\text{ mA}$) ($T_J = 25^\circ\text{C}$, $5.0\text{ mA} \leq I_O \leq 200\text{ mA}$) | Reg_{load} | – – | 20 10 | 120 60 | mV |
| Input Bias Current ($T_J = 25^\circ\text{C}$) | I_{IB} | – | 3.2 | 6.0 | mA |
| Quiescent Current Change ($9.0\text{ Vdc} \leq V_I \leq 25\text{ Vdc}$, $I_O = 200\text{ mA}$) ($5.0\text{ mA} \leq I_O \leq 350\text{ mA}$) | ΔI_{IB} | – – | – – | 0.8 0.5 | mA |
| Output Noise Voltage ($T_A = 25^\circ\text{C}$, $10\text{ Hz} \leq f \leq 100\text{ kHz}$) | V_n | – | 45 | – | μV |
| Ripple Rejection ($I_O = 100\text{ mA}$, $f = 120\text{ Hz}$, $9.0\text{ V} \leq V_I \leq 19\text{ V}$) ($I_O = 300\text{ mA}$, $f = 120\text{ Hz}$, $9.0\text{ V} \leq V_I \leq 19\text{ V}$, $T_J = 25^\circ\text{C}$) | RR | 59 59 | – 80 | – – | dB |
| Dropout Voltage ($T_J = 25^\circ\text{C}$) | $V_I - V_O$ | – | 2.0 | – | Vdc |
| Short Circuit Current Limit ($T_J = 25^\circ\text{C}$, $V_I = 35\text{ V}$) | I_{OS} | – | 350 | – | mA |
| Average Temperature Coefficient of Output Voltage ($I_O = 5.0\text{ mA}$) | $\Delta V_O/\Delta T$ | – | ± 0.2 | – | $\text{mV}/^\circ\text{C}$ |
| Peak Output Current ($T_J = 25^\circ\text{C}$) | I_O | – | 700 | – | mA |

MC78M08C/AC/B/AB, NCV78M08B ELECTRICAL CHARACTERISTICS

($V_I = 14\text{ V}$, $I_O = 350\text{ mA}$, $T_J = T_{\text{low}}$ to T_{high} , $P_D \leq 5\text{ W}$, unless otherwise noted) (Note 3)

| Characteristics | Symbol | Min | Typ | Max | Unit |
|---|----------------------------|--------------|------------|--------------|----------------------------|
| Output Voltage ($T_J = 25^\circ\text{C}$) MC78M08B/MC78M08C/NCV78M08B MC78M08AB/MC78M08AC | V_O | 7.70 7.84 | 8.0 8.0 | 8.30 8.16 | Vdc |
| Output Voltage Variation ($10.5\text{ Vdc} \leq V_I \leq 23\text{ Vdc}$, $5.0\text{ mA} \leq I_O \leq 350\text{ mA}$) MC78M08B/MC78M08C/NCV78M08B MC78M08AB/MC78M08AC | V_O | 7.6 7.7 | – – | 8.4 8.3 | Vdc |
| Line Regulation ($T_J = 25^\circ\text{C}$, $10.5\text{ Vdc} \leq V_I \leq 25\text{ Vdc}$, $I_O = 200\text{ mA}$) | Reg_{line} | – | 6.0 | 50 | mV |
| Load Regulation ($T_J = 25^\circ\text{C}$, $5.0\text{ mA} \leq I_O \leq 500\text{ mA}$) ($T_J = 25^\circ\text{C}$, $5.0\text{ mA} \leq I_O \leq 200\text{ mA}$) | Reg_{load} | – – | 25 10 | 160 80 | mV |
| Input Bias Current ($T_J = 25^\circ\text{C}$) | I_{IB} | – | 3.2 | 6.0 | mA |
| Quiescent Current Change ($10.5\text{ Vdc} \leq V_I \leq 25\text{ Vdc}$, $I_O = 200\text{ mA}$) ($5.0\text{ mA} \leq I_O \leq 350\text{ mA}$) | ΔI_{IB} | – – | – – | 0.8 0.5 | mA |
| Output Noise Voltage ($T_A = 25^\circ\text{C}$, $10\text{ Hz} \leq f \leq 100\text{ kHz}$) | V_n | – | 52 | – | μV |
| Ripple Rejection ($I_O = 100\text{ mA}$, $f = 120\text{ Hz}$, $11.5\text{ V} \leq V_I \leq 21.5\text{ V}$) ($I_O = 300\text{ mA}$, $f = 120\text{ Hz}$, $11.5\text{ V} \leq V_I \leq 21.5\text{ V}$, $T_J = 25^\circ\text{C}$) | RR | 56 56 | – 80 | – – | dB |
| Dropout Voltage ($T_J = 25^\circ\text{C}$) | $V_I - V_O$ | – | 2.0 | – | Vdc |
| Short Circuit Current Limit ($T_J = 25^\circ\text{C}$, $V_I = 35\text{ V}$) | I_{OS} | – | 350 | – | mA |
| Average Temperature Coefficient of Output Voltage ($I_O = 5.0\text{ mA}$) | $\Delta V_O/\Delta T$ | – | ± 0.2 | – | $\text{mV}/^\circ\text{C}$ |
| Peak Output Current ($T_J = 25^\circ\text{C}$) | I_O | – | 700 | – | mA |

3. $T_{\text{low}} = 0^\circ\text{C}$ for MC78MxxAC, C
 = -40°C for MC78MxxAB, B, NCV78MxxAB, B
 $T_{\text{high}} = +125^\circ\text{C}$ for MC78MxxAB, AC, B, C, NCV78MxxAB, B

MC78M00, MC78M00A, NCV78M00 Series

MC78M09C/B, NCV78M09B ELECTRICAL CHARACTERISTICS

($V_I = 15\text{ V}$, $I_O = 350\text{ mA}$, $T_J = T_{\text{low}}$ to T_{high} , $P_D \leq 5.0\text{ W}$, unless otherwise noted) (Note 4)

| Characteristics | Symbol | Min | Typ | Max | Unit |
|---|----------------------------|----------|-----------|------------|----------------------------|
| Output Voltage ($T_J = 25^\circ\text{C}$) | V_O | 8.64 | 9.0 | 9.45 | Vdc |
| Output Voltage Variation ($11.5\text{ Vdc} \leq V_I \leq 23\text{ Vdc}$, $5.0\text{ mA} \leq I_O \leq 350\text{ mA}$) | V_O | 8.55 | – | 9.45 | Vdc |
| Line Regulation ($T_J = 25^\circ\text{C}$, $11.5\text{ Vdc} \leq V_I \leq 25\text{ Vdc}$, $I_O = 200\text{ mA}$) | Reg_{line} | – | 6.0 | 50 | mV |
| Load Regulation ($T_J = 25^\circ\text{C}$, $5.0\text{ mA} \leq I_O \leq 500\text{ mA}$) ($T_J = 25^\circ\text{C}$, $5.0\text{ mA} \leq I_O \leq 200\text{ mA}$) | Reg_{load} | – – | 25 10 | 180 90 | mV |
| Input Bias Current ($T_J = 25^\circ\text{C}$) | I_{IB} | – | 3.2 | 6.0 | mA |
| Quiescent Current Change ($11.5\text{ Vdc} \leq V_I \leq 25\text{ Vdc}$, $I_O = 200\text{ mA}$) ($5.0\text{ mA} \leq I_O \leq 350\text{ mA}$) | ΔI_{IB} | – – | – – | 0.8 0.5 | mA |
| Output Noise Voltage ($T_A = 25^\circ\text{C}$, $10\text{ Hz} \leq f \leq 100\text{ kHz}$) | V_n | – | 52 | – | μV |
| Ripple Rejection ($I_O = 100\text{ mA}$, $f = 120\text{ Hz}$, $12.5\text{ V} \leq V_I \leq 22.5\text{ V}$) ($I_O = 300\text{ mA}$, $f = 120\text{ Hz}$, $12.5\text{ V} \leq V_I \leq 22.5\text{ V}$, $T_J = 25^\circ\text{C}$) | RR | 56 56 | – 80 | – – | dB |
| Dropout Voltage ($T_J = 25^\circ\text{C}$) | $V_I - V_O$ | – | 2.0 | – | Vdc |
| Short Circuit Current Limit ($T_J = 25^\circ\text{C}$, $V_I = 35\text{ V}$) | I_{OS} | – | 350 | – | mA |
| Average Temperature Coefficient of Output Voltage ($I_O = 5.0\text{ mA}$) | $\Delta V_O / \Delta T$ | – | ± 0.2 | – | $\text{mV}/^\circ\text{C}$ |
| Peak Output Current ($T_J = 25^\circ\text{C}$) | I_O | – | 700 | – | mA |

MC78M12C/AC/B/AB, NCV78M12B ELECTRICAL CHARACTERISTICS

($V_I = 19\text{ V}$, $I_O = 350\text{ mA}$, $T_J = T_{\text{low}}$ to T_{high} , $P_D \leq 5\text{ W}$, unless otherwise noted) (Note 4)

| Characteristics | Symbol | Min | Typ | Max | Unit |
|---|----------------------------|----------------|-----------|----------------|----------------------------|
| Output Voltage ($T_J = 25^\circ\text{C}$) MC78M12B/MC78M12C/NCV78M12B MC78M12AB/MC78M12AC | V_O | 11.50 11.76 | 12 12 | 12.50 12.24 | Vdc |
| Output Voltage Variation ($14.5\text{ Vdc} \leq V_I \leq 27\text{ Vdc}$, $5.0\text{ mA} \leq I_O \leq 350\text{ mA}$) MC78M12B/MC78M12C/NCV78M12B MC78M12AB/MC78M12AC | V_O | 11.4 11.5 | – – | 12.6 12.5 | Vdc |
| Line Regulation ($T_J = 25^\circ\text{C}$, $14.5\text{ Vdc} \leq V_I \leq 30\text{ Vdc}$, $I_O = 200\text{ mA}$) | Reg_{line} | – | 8.0 | 50 | mV |
| Load Regulation ($T_J = 25^\circ\text{C}$, $5.0\text{ mA} \leq I_O \leq 500\text{ mA}$) ($T_J = 25^\circ\text{C}$, $5.0\text{ mA} \leq I_O \leq 200\text{ mA}$) | Reg_{load} | – – | 25 10 | 240 120 | mV |
| Input Bias Current ($T_J = 25^\circ\text{C}$) | I_{IB} | – | 3.2 | 6.0 | mA |
| Quiescent Current Change ($14.5\text{ Vdc} \leq V_I \leq 30\text{ Vdc}$, $I_O = 200\text{ mA}$) ($5.0\text{ mA} \leq I_O \leq 350\text{ mA}$) | ΔI_{IB} | – – | – – | 0.8 0.5 | mA |
| Output Noise Voltage ($T_A = 25^\circ\text{C}$, $10\text{ Hz} \leq f \leq 100\text{ kHz}$) | V_n | – | 75 | – | μV |
| Ripple Rejection ($I_O = 100\text{ mA}$, $f = 120\text{ Hz}$, $15\text{ V} \leq V_I \leq 25\text{ V}$) ($I_O = 300\text{ mA}$, $f = 120\text{ Hz}$, $15\text{ V} \leq V_I \leq 25\text{ V}$, $T_J = 25^\circ\text{C}$) | RR | 55 55 | – 80 | – – | dB |
| Dropout Voltage ($T_J = 25^\circ\text{C}$) | $V_I - V_O$ | – | 2.0 | – | Vdc |
| Short Circuit Current Limit ($T_J = 25^\circ\text{C}$, $V_I = 35\text{ V}$) | I_{OS} | – | 350 | – | mA |
| Average Temperature Coefficient of Output Voltage ($I_O = 5.0\text{ mA}$) | $\Delta V_O / \Delta T$ | – | ± 0.3 | – | $\text{mV}/^\circ\text{C}$ |
| Peak Output Current ($T_J = 25^\circ\text{C}$) | I_O | – | 700 | – | mA |

4. $T_{\text{low}} = 0^\circ\text{C}$ for MC78MxxAC, C
 = -40°C for MC78MxxAB, B, NCV78MxxAB, B
 $T_{\text{high}} = +125^\circ\text{C}$ for MC78MxxAB, AC, B, C, NCV78MxxAB, B

MC78M00, MC78M00A, NCV78M00 Series

MC78M15C/AC/B/AB, NCV78M15B ELECTRICAL CHARACTERISTICS

($V_I = 23\text{ V}$, $I_O = 350\text{ mA}$, $T_J = T_{\text{low}}$ to T_{high} , $P_D \leq 5\text{ W}$, unless otherwise noted) (Note 5)

| Characteristics | Symbol | Min | Typ | Max | Unit |
|---|----------------------------|----------------|-----------|----------------|----------------------------|
| Output Voltage ($T_J = 25^\circ\text{C}$) MC78M15B/MC78M15C/NCV78M15B MC78M15AB/MC78M15AC | V_O | 14.4 14.7 | 15 15 | 15.6 15.3 | Vdc |
| Output Voltage Variation ($17.5\text{ Vdc} \leq V_I \leq 30\text{ Vdc}$, $5.0\text{ mA} \leq I_O \leq 350\text{ mA}$) MC78M15B/MC78M15C/NCV78M15B MC78M15AB/MC78M15AC | V_O | 14.25 14.40 | – – | 15.75 15.60 | Vdc |
| Input Regulation ($T_J = 25^\circ\text{C}$, $17.5\text{ Vdc} \leq V_I \leq 30\text{ Vdc}$, $I_O = 200\text{ mA}$) | Reg_{line} | – | 10 | 50 | mV |
| Load Regulation ($T_J = 25^\circ\text{C}$, $5.0\text{ mA} \leq I_O \leq 500\text{ mA}$) ($T_J = 25^\circ\text{C}$, $5.0\text{ mA} \leq I_O \leq 200\text{ mA}$) | Reg_{load} | – – | 25 10 | 300 150 | mV |
| Input Bias Current ($T_J = 25^\circ\text{C}$) | I_{IB} | – | 3.2 | 6.0 | mA |
| Quiescent Current Change ($17.5\text{ Vdc} \leq V_I \leq 30\text{ Vdc}$, $I_O = 200\text{ mA}$) ($5.0\text{ mA} \leq I_O \leq 350\text{ mA}$) | ΔI_{IB} | – – | – – | 0.8 0.5 | mA |
| Output Noise Voltage ($T_A = 25^\circ\text{C}$, $10\text{ Hz} \leq f \leq 100\text{ kHz}$) | V_n | – | 90 | – | μV |
| Ripple Rejection ($I_O = 100\text{ mA}$, $f = 120\text{ Hz}$, $18.5\text{ V} \leq V_I \leq 28.5\text{ V}$) ($I_O = 300\text{ mA}$, $f = 120\text{ Hz}$, $18.5\text{ V} \leq V_I \leq 28.5\text{ V}$, $T_J = 25^\circ\text{C}$) | RR | 54 54 | – 70 | – – | dB |
| Dropout Voltage ($T_J = 25^\circ\text{C}$) | $V_I - V_O$ | – | 2.0 | – | Vdc |
| Short Circuit Current Limit ($T_J = 25^\circ\text{C}$, $V_I = 35\text{ V}$) | I_{OS} | – | 350 | – | mA |
| Average Temperature Coefficient of Output Voltage ($I_O = 5.0\text{ mA}$) | $\Delta V_O / \Delta T$ | – | ± 0.3 | – | $\text{mV}/^\circ\text{C}$ |
| Peak Output Current ($T_J = 25^\circ\text{C}$) | I_O | – | 700 | – | mA |

MC78M18C/B ELECTRICAL CHARACTERISTICS

($V_I = 27\text{ V}$, $I_O = 350\text{ mA}$, $T_J = T_{\text{low}}$ to T_{high} , $P_D \leq 5\text{ W}$, unless otherwise noted) (Note 5)

| Characteristics | Symbol | Min | Typ | Max | Unit |
|---|----------------------------|----------|-----------|------------|----------------------------|
| Output Voltage ($T_J = 25^\circ\text{C}$) | V_O | 17.3 | 18 | 18.7 | Vdc |
| Output Voltage Variation ($21\text{ Vdc} \leq V_I \leq 33\text{ Vdc}$, $5.0\text{ mA} \leq I_O \leq 350\text{ mA}$) | V_O | 17.1 | – | 18.9 | Vdc |
| Line Regulation ($T_J = 25^\circ\text{C}$, $21\text{ Vdc} \leq V_I \leq 33\text{ Vdc}$, $I_O = 200\text{ mA}$) | Reg_{line} | – | 10 | 50 | mV |
| Load Regulation ($T_J = 25^\circ\text{C}$, $5.0\text{ mA} \leq I_O \leq 500\text{ mA}$) ($T_J = 25^\circ\text{C}$, $5.0\text{ mA} \leq I_O \leq 200\text{ mA}$) | Reg_{load} | – – | 30 10 | 360 180 | mV |
| Input Bias Current ($T_J = 25^\circ\text{C}$) | I_{IB} | – | 3.2 | 6.5 | mA |
| Quiescent Current Change ($21\text{ Vdc} \leq V_I \leq 33\text{ Vdc}$, $I_O = 200\text{ mA}$) ($5.0\text{ mA} \leq I_O \leq 350\text{ mA}$) | ΔI_{IB} | – – | – – | 0.8 0.5 | mA |
| Output Noise Voltage ($T_A = 25^\circ\text{C}$, $10\text{ Hz} \leq f \leq 100\text{ kHz}$) | V_n | – | 100 | – | μV |
| Ripple Rejection ($I_O = 100\text{ mA}$, $f = 120\text{ Hz}$, $22\text{ V} \leq V_I \leq 32\text{ V}$) ($I_O = 300\text{ mA}$, $f = 120\text{ Hz}$, $22\text{ V} \leq V_I \leq 32\text{ V}$, $T_J = 25^\circ\text{C}$) | RR | 53 53 | – 70 | – – | dB |
| Dropout Voltage ($T_J = 25^\circ\text{C}$) | $V_I - V_O$ | – | 2.0 | – | Vdc |
| Short Circuit Current Limit ($T_J = 25^\circ\text{C}$, $V_I = 35\text{ V}$) | I_{OS} | – | 350 | – | mA |
| Average Temperature Coefficient of Output Voltage ($I_O = 5.0\text{ mA}$) | $\Delta V_O / \Delta T$ | – | ± 0.3 | – | $\text{mV}/^\circ\text{C}$ |
| Peak Output Current ($T_J = 25^\circ\text{C}$) | I_O | – | 700 | – | mA |

5. $T_{\text{low}} = 0^\circ\text{C}$ for MC78MxxAC, C
 = -40°C for MC78MxxAB, B, NCV78MxxAB, B
 $T_{\text{high}} = +125^\circ\text{C}$ for MC78MxxAB, AC, B, C, NCV78MxxAB, B

MC78M00, MC78M00A, NCV78M00 Series

MC78M20C/B ELECTRICAL CHARACTERISTICS

($V_I = 29\text{ V}$, $I_O = 350\text{ mA}$, $T_J = T_{\text{low}}$ to T_{high} , $P_D \leq 5.0\text{ W}$, unless otherwise noted) (Note 6)

| Characteristics | Symbol | Min | Typ | Max | Unit |
|---|----------------------------|----------|-----------|------------|----------------------------|
| Output Voltage ($T_J = 25^\circ\text{C}$) | V_O | 19.2 | 20 | 20.8 | Vdc |
| Output Voltage Variation ($23\text{ Vdc} \leq V_I \leq 35\text{ Vdc}$, $5.0\text{ mA} \leq I_O \leq 350\text{ mA}$) | V_O | 19 | – | 21 | Vdc |
| Line Regulation ($T_J = 25^\circ\text{C}$, $23\text{ Vdc} \leq V_I \leq 35\text{ Vdc}$, $I_O = 200\text{ mA}$) | Reg_{line} | – | 10 | 50 | mV |
| Load Regulation ($T_J = 25^\circ\text{C}$, $5.0\text{ mA} \leq I_O \leq 500\text{ mA}$) ($T_J = 25^\circ\text{C}$, $5.0\text{ mA} \leq I_O \leq 200\text{ mA}$) | Reg_{load} | – | 30 10 | 400 200 | mV |
| Input Bias Current ($T_J = 25^\circ\text{C}$) | I_{IB} | – | 3.2 | 6.5 | mA |
| Quiescent Current Change ($23\text{ Vdc} \leq V_I \leq 35\text{ Vdc}$, $I_O = 200\text{ mA}$) ($5.0\text{ mA} \leq I_O \leq 350\text{ mA}$) | ΔI_{IB} | – | – | 0.8 0.5 | mA |
| Output Noise Voltage ($T_A = 25^\circ\text{C}$, $10\text{ Hz} \leq f \leq 100\text{ kHz}$) | V_n | – | 110 | – | μV |
| Ripple Rejection ($I_O = 100\text{ mA}$, $f = 120\text{ Hz}$, $24\text{ V} \leq V_I \leq 34\text{ V}$) ($I_O = 300\text{ mA}$, $f = 120\text{ Hz}$, $24\text{ V} \leq V_I \leq 34\text{ V}$, $T_J = 25^\circ\text{C}$) | RR | 52 52 | – 70 | – – | dB |
| Dropout Voltage ($T_J = 25^\circ\text{C}$) | $V_I - V_O$ | – | 2.0 | – | Vdc |
| Short Circuit Current Limit ($T_J = 25^\circ\text{C}$, $V_I = 35\text{ V}$) | I_{OS} | – | 350 | – | mA |
| Average Temperature Coefficient of Output Voltage ($I_O = 5.0\text{ mA}$) | $\Delta V_O / \Delta T$ | – | ± 0.5 | – | $\text{mV}/^\circ\text{C}$ |
| Peak Output Current ($T_J = 25^\circ\text{C}$) | I_O | – | 700 | – | mA |

MC78M24C/B ELECTRICAL CHARACTERISTICS

($V_I = 33\text{ V}$, $I_O = 350\text{ mA}$, $T_J = T_{\text{low}}$ to T_{high} , $P_D \leq 5.0\text{ W}$, unless otherwise noted) (Note 6)

| Characteristics | Symbol | Min | Typ | Max | Unit |
|---|----------------------------|----------|-----------|------------|----------------------------|
| Output Voltage ($T_J = 25^\circ\text{C}$) | V_O | 23 | 24 | 25 | Vdc |
| Output Voltage Variation ($27\text{ Vdc} \leq V_I \leq 38\text{ Vdc}$, $5.0\text{ mA} \leq I_O \leq 350\text{ mA}$) | V_O | 22.8 | – | 25.2 | Vdc |
| Line Regulation ($T_J = 25^\circ\text{C}$, $27\text{ Vdc} \leq V_I \leq 38\text{ Vdc}$, $I_O = 200\text{ mA}$) | Reg_{line} | – | 10 | 50 | mV |
| Load Regulation ($T_J = 25^\circ\text{C}$, $5.0\text{ mA} \leq I_O \leq 500\text{ mA}$) ($T_J = 25^\circ\text{C}$, $5.0\text{ mA} \leq I_O \leq 200\text{ mA}$) | Reg_{load} | – | 30 10 | 480 240 | mV |
| Input Bias Current ($T_J = 25^\circ\text{C}$) | I_{IB} | – | 3.2 | 7.0 | mA |
| Quiescent Current Change ($27\text{ Vdc} \leq V_I \leq 38\text{ Vdc}$, $I_O = 200\text{ mA}$) ($5.0\text{ mA} \leq I_O \leq 350\text{ mA}$) | ΔI_{IB} | – | – | 0.8 0.5 | mA |
| Output Noise Voltage ($T_A = 25^\circ\text{C}$, $10\text{ Hz} \leq f \leq 100\text{ kHz}$) | V_n | – | 170 | – | μV |
| Ripple Rejection ($I_O = 100\text{ mA}$, $f = 120\text{ Hz}$, $28\text{ V} \leq V_I \leq 38\text{ V}$) ($I_O = 300\text{ mA}$, $f = 120\text{ Hz}$, $28\text{ V} \leq V_I \leq 38\text{ V}$, $T_J = 25^\circ\text{C}$) | RR | 50 50 | – 70 | – – | dB |
| Dropout Voltage ($T_J = 25^\circ\text{C}$) | $V_I - V_O$ | – | 2.0 | – | Vdc |
| Short Circuit Current Limit ($T_J = 25^\circ\text{C}$) | I_{OS} | – | 350 | – | mA |
| Average Temperature Coefficient of Output Voltage ($I_O = 5.0\text{ mA}$) | $\Delta V_O / \Delta T$ | – | ± 0.5 | – | $\text{mV}/^\circ\text{C}$ |
| Peak Output Current ($T_J = 25^\circ\text{C}$) | I_O | – | 700 | – | mA |

6. $T_{\text{low}} = 0^\circ\text{C}$ for MC78MxxAC, C
 $= -40^\circ\text{C}$ for MC78MxxAB, B
 $T_{\text{high}} = +125^\circ\text{C}$ for MC78MxxAB, AC, B, C

DEFINITIONS

Line Regulation – The change in output voltage for a change in the input voltage. The measurement is made under conditions of low dissipation or by using pulse techniques such that the average chip temperature is not significantly affected.

Load Regulation – The change in output voltage for a change in load current at constant chip temperature.

Maximum Power Dissipation – The maximum total device dissipation for which the regulator will operate within specifications.

Input Bias Current – That part of the input current that is not delivered to the load.

Output Noise Voltage – The rms AC voltage at the output, with constant load and no input ripple, measured over a specified frequency range.

Long Term Stability – Output voltage stability under accelerated life test conditions with the maximum rated voltage listed in the devices' electrical characteristics and maximum power dissipation.

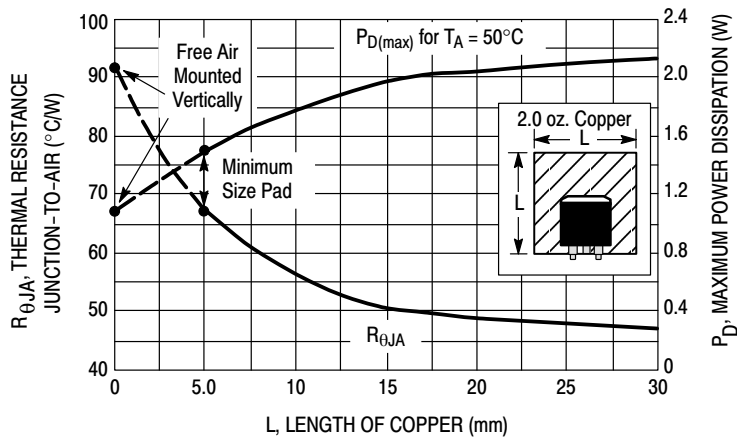

Figure 2. DPAK Thermal Resistance and Maximum Power Dissipation versus P.C.B. Copper Length

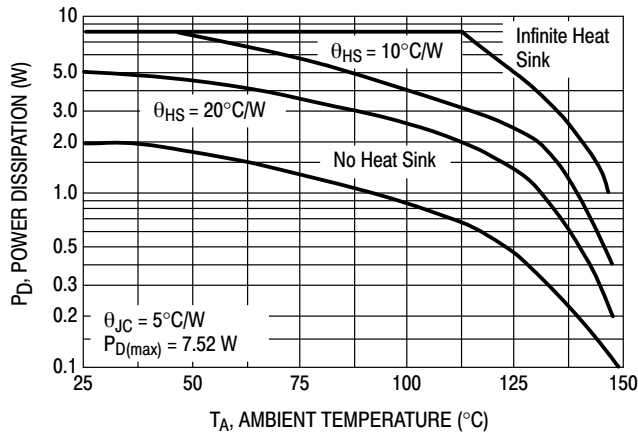

Figure 3. Worst Case Power Dissipation versus Ambient Temperature (TO-220)

MC78M00, MC78M00A, NCV78M00 Series



Figure 4. Peak Output Current versus Dropout Voltage



Figure 5. Dropout Voltage versus Junction Temperature



Figure 6. Ripple Rejection versus Frequency



Figure 7. Ripple Rejection versus Output Current



Figure 8. Bias Current versus Input Voltage



Figure 9. Bias Current versus Output Current

APPLICATIONS INFORMATION

Design Considerations

The MC78M00/MC78M00A Series of fixed voltage regulators are designed with Thermal Overload Protection that shuts down the circuit when subjected to an excessive power overload condition, Internal Short Circuit Protection that limits the maximum current the circuit will pass, and Output Transistor Safe-Area Compensation that reduces the output short circuit current as the voltage across the pass transistor is increased.

In many low current applications, compensation capacitors are not required. However, it is recommended that the regulator input be bypassed with a capacitor if the

regulator is connected to the power supply filter with long wire lengths, or if the output load capacitance is large. An input bypass capacitor should be selected to provide good high frequency characteristics to insure stable operation under all load conditions. A 0.33 μF or larger tantalum, mylar, or other capacitor having low internal impedance at high frequencies should be chosen. The bypass capacitor should be mounted with the shortest possible leads directly across the regulator's input terminals. Normally good construction techniques should be used to minimize ground loops and lead resistance drops since the regulator has no external sense lead.



The MC78M00 regulators can also be used as a current source when connected as above. In order to minimize dissipation the MC78M05C is chosen in this application. Resistor R determines the current as follows:

$$I_o = \frac{5.0\text{ V}}{R} + I_{IB}$$

$I_{IB} = 1.5\text{ mA}$ over line and load changes.

For example, a 500 mA current source would require R to be a 10 Ω, 10 W resistor and the output voltage compliance would be the input voltage less 7.0 V.

Figure 10. Current Regulator



The addition of an operational amplifier allows adjustment to higher or intermediate values while retaining regulation characteristics. The minimum voltage obtainable with this arrangement is 2.0 V greater than the regulator voltage.

Figure 11. Adjustable Output Regulator



XX = 2 digits of type number indicating voltage.

The MC78M00 series can be current boosted with a PNP transistor. The MJ2955 provides current to 5.0 A. Resistor R in conjunction with the V_{BE} of the PNP determines when the pass transistor begins conducting; this circuit is not short circuit proof. Input-output differential voltage minimum is increased by V_{BE} of the pass transistor.

Figure 12. Current Boost Regulator

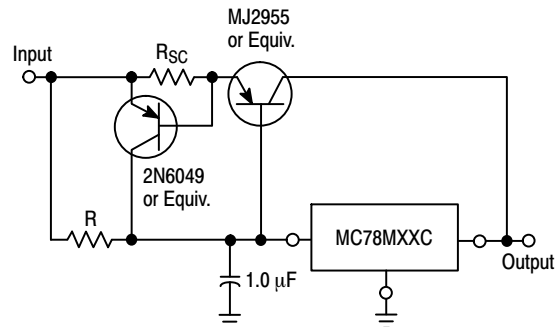

XX = 2 digits of type number indicating voltage.

The circuit of Figure 12 can be modified to provide supply protection against short circuits by adding a short circuit sense resistor, R_{sc} , and an additional PNP transistor. The current sensing PNP must be able to handle the short circuit current of the three-terminal regulator. Therefore, a 4.0 A plastic power transistor is specified.

Figure 13. Current Boost with Short Circuit Protection

MC78M00, MC78M00A, NCV78M00 Series

ORDERING INFORMATION

| Device | Output Voltage | Temperature Range | Package | Marking | Shipping [†] |
|------------------|----------------|---------------------------------|------------------|---------|--------------------------|
| MC78M05CDTG | 5.0 V | T _J = 0° to +125°C | DPAK-3 (Pb-Free) | 78M05 | 75 Units / Rail |
| MC78M05CDTRKG | 5.0 V | T _J = 0° to +125°C | DPAK-3 (Pb-Free) | 78M05 | 2500 / Tape & Reel |
| MC78M05ACDTRKG | 5.0 V | T _J = 0° to +125°C | DPAK-3 (Pb-Free) | 8M05D | 2500 / Tape & Reel |
| MC78M05CTG | 5.0 V | T _J = 0° to +125°C | TO-220 (Pb-Free) | 78M05CT | 50 Units / Rail |
| MC78M05ABDTG | 5.0 V | T _J = -40° to +125°C | DPAK-3 (Pb-Free) | 8M05A | 75 Units / Rail |
| MC78M05ABDTRKG | 5.0 V | T _J = -40° to +125°C | DPAK-3 (Pb-Free) | 8M05A | 2500 / Tape & Reel |
| NCV78M05ABDTRKG* | 5.0 V | T _J = -40° to +125°C | DPAK-3 (Pb-Free) | 8M05A | 2500 / Tape & Reel |
| MC78M05BDTG | 5.0 V | T _J = -40° to +125°C | DPAK-3 (Pb-Free) | 8M05B | 75 Units / Rail |
| MC78M05BDTRKG | 5.0 V | T _J = -40° to +125°C | DPAK-3 (Pb-Free) | 8M05B | 2500 / Tape & Reel |
| NCV78M05BDTRKG* | 5.0 V | T _J = -40° to +125°C | DPAK-3 (Pb-Free) | 8M05B | 2500 / Tape & Reel |
| MC78M05BTG | 5.0 V | T _J = -40° to +125°C | TO-220 (Pb-Free) | 78M05BT | 50 Units / Rail |
| NCV78M05BTG* | 5.0 V | T _J = -40° to +125°C | TO-220 (Pb-Free) | 78M05BT | 50 Units / Rail |
| MC78M06CDTRKG | 6.0 V | T _J = 0° to +125°C | DPAK-3 (Pb-Free) | 78M06 | 2500 / Tape & Reel |
| MC78M08CDTRKG | 8.0 V | T _J = 0° to +125°C | DPAK-3 (Pb-Free) | 78M08 | 2500 Units / Tape & Reel |
| MC78M08BDTRKG | 8.0 V | T _J = -40° to +125°C | DPAK-3 (Pb-Free) | 8M08B | 2500 Units / Tape & Reel |
| NCV78M08BDTRKG* | 8.0 V | T _J = -40° to +125°C | DPAK-3 (Pb-Free) | 8M08B | 2500 Units / Tape & Reel |
| MC78M09CDTRKG | 9.0 V | T _J = 0° to +125°C | DPAK-3 (Pb-Free) | 78M09 | 2500 Units / Tape & Reel |
| MC78M09BDTRKG | 9.0 V | T _J = -40° to +125°C | DPAK-3 (Pb-Free) | 8M09B | 2500 Units / Tape & Reel |
| NCV78M09BDTRKG* | 9.0 V | T _J = -40° to +125°C | DPAK-3 (Pb-Free) | 8M09B | 2500 Units / Tape & Reel |
| MC78M12CDTG | 12 V | T _J = 0° to +125°C | DPAK-3 (Pb-Free) | 78M12 | 75 Units / Rail |
| MC78M12CDTRKG | 12 V | T _J = 0° to +125°C | DPAK-3 (Pb-Free) | 78M12 | 2500 Units / Tape & Reel |
| MC78M12ACDTRKG | 12 V | T _J = 0° to +125°C | DPAK-3 (Pb-Free) | 8M12D | 2500 Units / Tape & Reel |
| MC78M12CTG | 12 V | T _J = 0° to +125°C | TO-220 (Pb-Free) | 78M12CT | 50 Units / Rail |

[†]For information on tape and reel specifications, including part orientation and tape sizes, please refer to our Tape and Reel Packaging Specifications Brochure, BRD8011/D.

*NCV devices: T_{low} = -40°C, T_{high} = +125°C. Guaranteed by design. NCV Prefix for Automotive and Other Applications Requiring Unique Site and Control Change Requirements; AEC-Q100 Qualified and PPAP Capable.

MC78M00, MC78M00A, NCV78M00 Series

ORDERING INFORMATION (continued)

| Device | Output Voltage | Temperature Range | Package | Marking | Shipping [†] |
|-----------------|----------------|--|------------------|---------|--------------------------|
| MC78M12ABDTRKG | 12 V | $T_J = -40^\circ \text{ to } +125^\circ\text{C}$ | DPAK-3 (Pb-Free) | 8M12A | 2500 Units / Tape & Reel |
| MC78M12BDTG | 12 V | $T_J = -40^\circ \text{ to } +125^\circ\text{C}$ | DPAK-3 (Pb-Free) | 8M12B | 75 Units / Rail |
| MC78M12BDTRKG | 12 V | $T_J = -40^\circ \text{ to } +125^\circ\text{C}$ | DPAK-3 (Pb-Free) | 8M12B | 2500 Units / Tape & Reel |
| NCV78M12BDTRKG* | 12 V | $T_J = -40^\circ \text{ to } +125^\circ\text{C}$ | DPAK-3 (Pb-Free) | 8M12B | 2500 Units / Tape & Reel |
| MC78M12BTG | 12 V | $T_J = -40^\circ \text{ to } +125^\circ\text{C}$ | TO-220 (Pb-Free) | 78M12BT | 50 Units / Rail |
| MC78M15CDTG | 15 V | $T_J = 0^\circ \text{ to } +125^\circ\text{C}$ | DPAK-3 (Pb-Free) | 78M15 | 75 Units / Rail |
| MC78M15CDTRKG | 15 V | $T_J = 0^\circ \text{ to } +125^\circ\text{C}$ | DPAK-3 (Pb-Free) | 78M15 | 2500 Units / Tape & Reel |
| MC78M15ACDTRKG | 15 V | $T_J = 0^\circ \text{ to } +125^\circ\text{C}$ | DPAK-3 (Pb-Free) | 8M15D | 2500 Units / Tape & Reel |
| MC78M15CTG | 15 V | $T_J = 0^\circ \text{ to } +125^\circ\text{C}$ | TO-220 (Pb-Free) | 78M15CT | 50 Units / Rail |
| MC78M15ABDTRKG | 15 V | $T_J = -40^\circ \text{ to } +125^\circ\text{C}$ | DPAK-3 (Pb-Free) | 8M15A | 2500 Units / Tape & Reel |
| NCV78M15BDTG* | 15 V | $T_J = -40^\circ \text{ to } +125^\circ\text{C}$ | DPAK-3 (Pb-Free) | 8M15B | 75 Units / Rail |
| MC78M15BDTRKG | 15 V | $T_J = -40^\circ \text{ to } +125^\circ\text{C}$ | DPAK-3 (Pb-Free) | 8M15B | 2500 Units / Tape & Reel |
| NCV78M15BDTRKG* | 15 V | $T_J = -40^\circ \text{ to } +125^\circ\text{C}$ | DPAK-3 (Pb-Free) | 8M15B | 2500 Units / Tape & Reel |
| MC78M18CDTRKG | 18 V | $T_J = 0^\circ \text{ to } +125^\circ\text{C}$ | DPAK-3 (Pb-Free) | 78M18 | 2500 Units / Tape & Reel |

[†]For information on tape and reel specifications, including part orientation and tape sizes, please refer to our Tape and Reel Packaging Specifications Brochure, BRD8011/D.

*NCV devices: $T_{\text{low}} = -40^\circ\text{C}$, $T_{\text{high}} = +125^\circ\text{C}$. Guaranteed by design. NCV Prefix for Automotive and Other Applications Requiring Unique Site and Control Change Requirements; AEC-Q100 Qualified and PPAP Capable.

MECHANICAL CASE OUTLINE

PACKAGE DIMENSIONS

ON Semiconductor®



TO-220, SINGLE GAUGE CASE 221AB-01 ISSUE A

DATE 16 NOV 2010

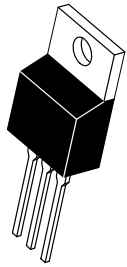

SCALE 1:1

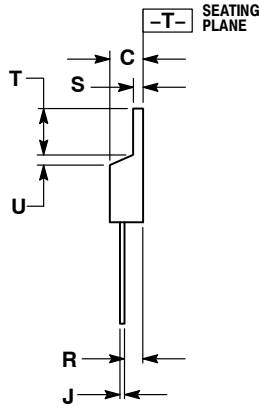

NOTES:

1. DIMENSIONING AND TOLERANCING PER ANSI Y14.5M, 1982.
2. CONTROLLING DIMENSION: INCHES.
3. DIMENSION Z DEFINES A ZONE WHERE ALL BODY AND LEAD IRREGULARITIES ARE ALLOWED.
4. PRODUCT SHIPPED PRIOR TO 2008 HAD DIMENSIONS S = 0.045 - 0.055 INCHES (1.143 - 1.397 MM)

| DIM | INCHES | | MILLIMETERS | |
|-----|--------|-------|-------------|-------|
| | MIN | MAX | MIN | MAX |
| A | 0.570 | 0.620 | 14.48 | 15.75 |
| B | 0.380 | 0.405 | 9.66 | 10.28 |
| C | 0.160 | 0.190 | 4.07 | 4.82 |
| D | 0.025 | 0.035 | 0.64 | 0.88 |
| F | 0.142 | 0.147 | 3.61 | 3.73 |
| G | 0.095 | 0.105 | 2.42 | 2.66 |
| H | 0.110 | 0.155 | 2.80 | 3.93 |
| J | 0.018 | 0.025 | 0.46 | 0.64 |
| K | 0.500 | 0.562 | 12.70 | 14.27 |
| L | 0.045 | 0.060 | 1.15 | 1.52 |
| N | 0.190 | 0.210 | 4.83 | 5.33 |
| Q | 0.100 | 0.120 | 2.54 | 3.04 |
| R | 0.080 | 0.110 | 2.04 | 2.79 |
| S | 0.020 | 0.024 | 0.508 | 0.61 |
| T | 0.235 | 0.255 | 5.97 | 6.47 |
| U | 0.000 | 0.050 | 0.00 | 1.27 |
| V | 0.045 | --- | 1.15 | --- |
| Z | --- | 0.080 | --- | 2.04 |

STYLE 1:

- PIN 1. BASE
- 2. COLLECTOR
- 3. EMITTER
- 4. COLLECTOR

STYLE 2:

- PIN 1. BASE
- 2. EMITTER
- 3. COLLECTOR
- 4. EMITTER

STYLE 3:

- PIN 1. CATHODE
- 2. ANODE
- 3. GATE
- 4. ANODE

STYLE 4:

- PIN 1. MAIN TERMINAL 1
- 2. MAIN TERMINAL 2
- 3. GATE
- 4. MAIN TERMINAL 2

STYLE 5:

- PIN 1. GATE
- 2. DRAIN
- 3. SOURCE
- 4. DRAIN

STYLE 6:

- PIN 1. ANODE
- 2. CATHODE
- 3. ANODE
- 4. CATHODE

STYLE 7:

- PIN 1. CATHODE
- 2. ANODE
- 3. CATHODE
- 4. ANODE

STYLE 8:

- PIN 1. CATHODE
- 2. ANODE
- 3. EXTERNAL TRIP/DELAY
- 4. ANODE

STYLE 9:

- PIN 1. GATE
- 2. COLLECTOR
- 3. EMITTER
- 4. COLLECTOR

STYLE 10:

- PIN 1. GATE
- 2. SOURCE
- 3. DRAIN
- 4. SOURCE

STYLE 11:

- PIN 1. DRAIN
- 2. SOURCE
- 3. GATE
- 4. SOURCE

| | | |
|-------------------------|-----------------------------|---|
| DOCUMENT NUMBER: | 98AON23085D | Electronic versions are uncontrolled except when accessed directly from the Document Repository. Printed versions are uncontrolled except when stamped "CONTROLLED COPY" in red. |
| DESCRIPTION: | TO-220, SINGLE GAUGE | PAGE 1 OF 1 |

ON Semiconductor and are trademarks of Semiconductor Components Industries, LLC dba ON Semiconductor or its subsidiaries in the United States and/or other countries. ON Semiconductor reserves the right to make changes without further notice to any products herein. ON Semiconductor makes no warranty, representation or guarantee regarding the suitability of its products for any particular purpose, nor does ON Semiconductor assume any liability arising out of the application or use of any product or circuit, and specifically disclaims any and all liability, including without limitation special, consequential or incidental damages. ON Semiconductor does not convey any license under its patent rights nor the rights of others.

MECHANICAL CASE OUTLINE

PACKAGE DIMENSIONS

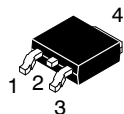

DPAK (SINGLE GAUGE)

CASE 369C

ISSUE G

DATE 31 MAY 2023

SCALE 1:1

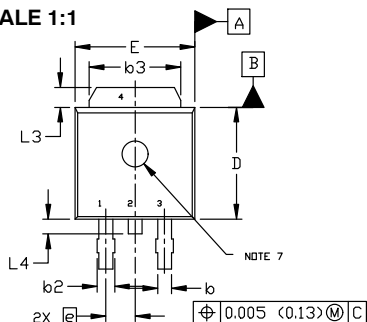

TOP VIEW

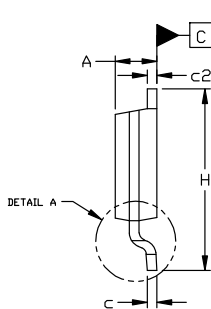

SIDE VIEW

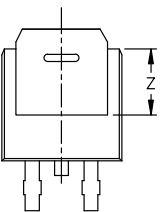
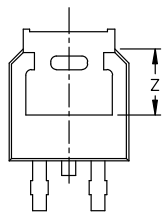
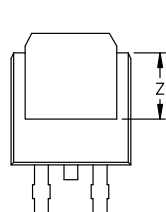

BOTTOM VIEW

BOTTOM VIEW

ALTERNATE CONSTRUCTIONS

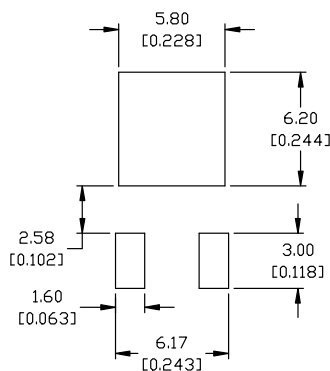

RECOMMENDED MOUNTING FOOTPRINT*

*FOR ADDITIONAL INFORMATION ON OUR Pb-FREE STRATEGY AND SOLDERING DETAILS, PLEASE DOWNLOAD THE ON SEMICONDUCTOR SOLDERING AND MOUNTING TECHNIQUES REFERENCE MANUAL, SOLDERM/D.

- | | | | | |
|--|--|---|---|--|
| STYLE 1: PIN 1. BASE 2. COLLECTOR 3. EMITTER 4. COLLECTOR | STYLE 2: PIN 1. GATE 2. DRAIN 3. SOURCE 4. DRAIN | STYLE 3: PIN 1. ANODE 2. CATHODE 3. ANODE 4. CATHODE | STYLE 4: PIN 1. CATHODE 2. ANODE 3. GATE 4. ANODE | STYLE 5: PIN 1. GATE 2. ANODE 3. CATHODE 4. ANODE |
| STYLE 6: PIN 1. MT1 2. MT2 3. GATE 4. MT2 | STYLE 7: PIN 1. GATE 2. COLLECTOR 3. EMITTER 4. COLLECTOR | STYLE 8: PIN 1. N/C 2. CATHODE 3. ANODE 4. CATHODE | STYLE 9: PIN 1. ANODE 2. CATHODE 3. RESISTOR ADJUST 4. CATHODE | STYLE 10: PIN 1. CATHODE 2. ANODE 3. CATHODE 4. ANODE |

NOTES:

- DIMENSIONING AND TOLERANCING ASME Y14.5M, 1994.
- CONTROLLING DIMENSION: INCHES
- THERMAL PAD CONTOUR OPTIONAL WITHIN DIMENSIONS b3, L3, AND Z.
- DIMENSIONS D AND E DO NOT INCLUDE MOLD FLASH, PROTRUSIONS, OR BURRS. MOLD FLASH, PROTRUSIONS, OR GATE BURRS SHALL NOT EXCEED 0.006 INCHES PER SIDE.
- DIMENSIONS D AND E ARE DETERMINED AT THE OUTERMOST EXTREMES OF THE PLASTIC BODY.
- DATUMS A AND B ARE DETERMINED AT DATUM PLANE H.
- OPTIONAL MOLD FEATURE.

| DIM | INCHES | | MILLIMETERS | |
|-----|--------|-------|-------------|-------|
| | MIN. | MAX. | MIN. | MAX. |
| A | 0.086 | 0.094 | 2.18 | 2.38 |
| A1 | 0.000 | 0.005 | 0.00 | 0.13 |
| b | 0.025 | 0.035 | 0.63 | 0.89 |
| b2 | 0.028 | 0.045 | 0.72 | 1.14 |
| b3 | 0.180 | 0.215 | 4.57 | 5.46 |
| c | 0.018 | 0.024 | 0.46 | 0.61 |
| c2 | 0.018 | 0.024 | 0.46 | 0.61 |
| D | 0.235 | 0.245 | 5.97 | 6.22 |
| E | 0.250 | 0.265 | 6.35 | 6.73 |
| e | 0.090 | BSC | 2.29 | BSC |
| H | 0.370 | 0.410 | 9.40 | 10.41 |
| L | 0.055 | 0.070 | 1.40 | 1.78 |
| L1 | 0.114 | REF | 2.90 | REF |
| L2 | 0.020 | BSC | 0.51 | BSC |
| L3 | 0.035 | 0.050 | 0.89 | 1.27 |
| L4 | ---- | 0.040 | --- | 1.01 |
| Z | 0.155 | ---- | 3.93 | --- |

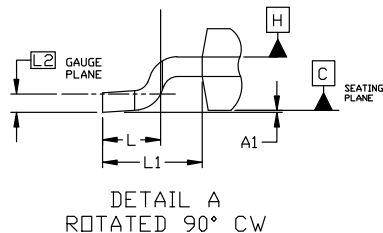

DETAIL A
ROTATED 90° CW

GENERIC MARKING DIAGRAM*

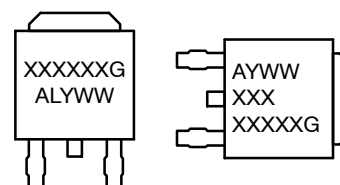

IC

Discrete

- XXXXXX = Device Code
- A = Assembly Location
- L = Wafer Lot
- Y = Year
- WW = Work Week
- G = Pb-Free Package

*This information is generic. Please refer to device data sheet for actual part marking. Pb-Free indicator, "G" or microdot "•", may or may not be present. Some products may not follow the Generic Marking.

| | | |
|-------------------------|----------------------------|---|
| DOCUMENT NUMBER: | 98AON10527D | Electronic versions are uncontrolled except when accessed directly from the Document Repository. Printed versions are uncontrolled except when stamped "CONTROLLED COPY" in red. |
| DESCRIPTION: | DPAK (SINGLE GAUGE) | PAGE 1 OF 1 |

onsemi and onsemi are trademarks of Semiconductor Components Industries, LLC dba onsemi or its subsidiaries in the United States and/or other countries. onsemi reserves the right to make changes without further notice to any products herein. onsemi makes no warranty, representation or guarantee regarding the suitability of its products for any particular purpose, nor does onsemi assume any liability arising out of the application or use of any product or circuit, and specifically disclaims any and all liability, including without limitation special, consequential or incidental damages. onsemi does not convey any license under its patent rights nor the rights of others.

onsemi, **Onsemi**, and other names, marks, and brands are registered and/or common law trademarks of Semiconductor Components Industries, LLC dba "**onsemi**" or its affiliates and/or subsidiaries in the United States and/or other countries. **onsemi** owns the rights to a number of patents, trademarks, copyrights, trade secrets, and other intellectual property. A listing of **onsemi**'s product/patent coverage may be accessed at www.onsemi.com/site/pdf/Patent-Marking.pdf. **onsemi** reserves the right to make changes at any time to any products or information herein, without notice. The information herein is provided "as-is" and **onsemi** makes no warranty, representation or guarantee regarding the accuracy of the information, product features, availability, functionality, or suitability of its products for any particular purpose, nor does **onsemi** assume any liability arising out of the application or use of any product or circuit, and specifically disclaims any and all liability, including without limitation special, consequential or incidental damages. Buyer is responsible for its products and applications using **onsemi** products, including compliance with all laws, regulations and safety requirements or standards, regardless of any support or applications information provided by **onsemi**. "Typical" parameters which may be provided in **onsemi** data sheets and/or specifications can and do vary in different applications and actual performance may vary over time. All operating parameters, including "Typicals" must be validated for each customer application by customer's technical experts. **onsemi** does not convey any license under any of its intellectual property rights nor the rights of others. **onsemi** products are not designed, intended, or authorized for use as a critical component in life support systems or any FDA Class 3 medical devices or medical devices with a same or similar classification in a foreign jurisdiction or any devices intended for implantation in the human body. Should Buyer purchase or use **onsemi** products for any such unintended or unauthorized application, Buyer shall indemnify and hold **onsemi** and its officers, employees, subsidiaries, affiliates, and distributors harmless against all claims, costs, damages, and expenses, and reasonable attorney fees arising out of, directly or indirectly, any claim of personal injury or death associated with such unintended or unauthorized use, even if such claim alleges that **onsemi** was negligent regarding the design or manufacture of the part. **onsemi** is an Equal Opportunity/Affirmative Action Employer. This literature is subject to all applicable copyright laws and is not for resale in any manner.

ADDITIONAL INFORMATION

TECHNICAL PUBLICATIONS:

Technical Library: www.onsemi.com/design/resources/technical-documentation
onsemi Website: www.onsemi.com

ONLINE SUPPORT: www.onsemi.com/support

For additional information, please contact your local Sales Representative at www.onsemi.com/support/sales